

SPECIFICATION SHEET

Porscha Luxe Slim 900 2-Drawer Wall Hung Vanity



Features

- 2-Drawer Wall Hung Vanity with Slab Top and Designer Drawer Front
- Multiple Slab Top Options Available
- Full Extension Soft Close Drawers with Extrusions - *Extrusion upgrade options available*
- Designer Drawer Fronts are pre-installed on all vanities
- Dimensions: H670 x W900 x D350

Note: Vessel basins are purchased separately.
Limited tap hole positions & vessel basin options.

Technical Details

Note: All measurements shown are in millimetres. Sizes are nominal.

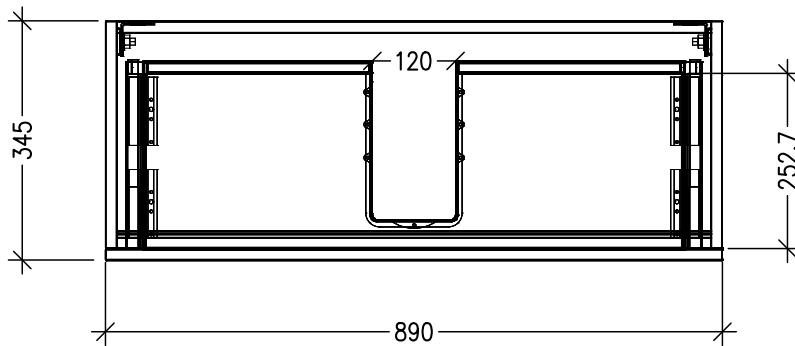

TOP VIEW

IMPORTANT

For installation, please ensure cabinet is fixed through middle division brackets into solid fixings.

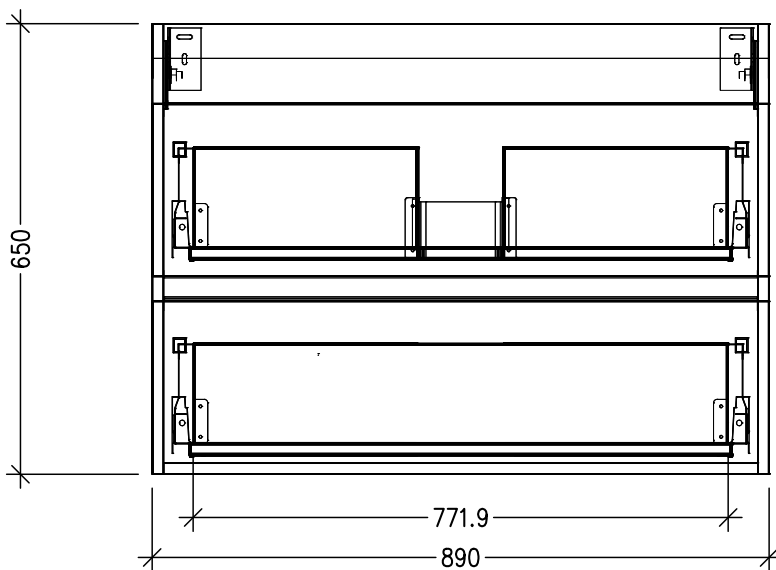

FRONT VIEW

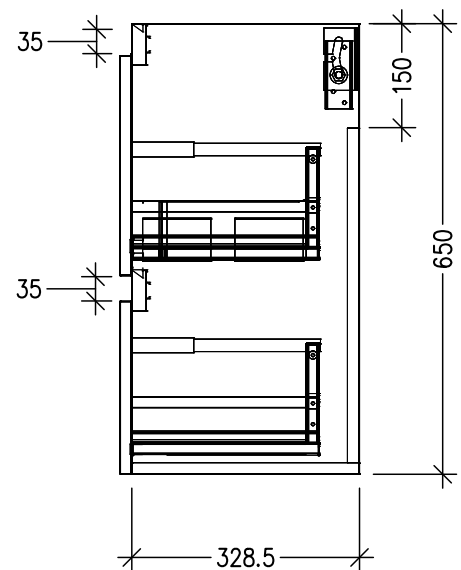

SIDE VIEW

SPECIFICATION SHEET

Slab Top Options

StoneCast Slab Top 900

W900 x D350 x H20

Gloss White - Code: SC

Matte White - Code: SCMW

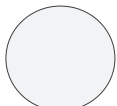

Gloss White

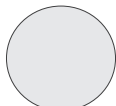

Matte White

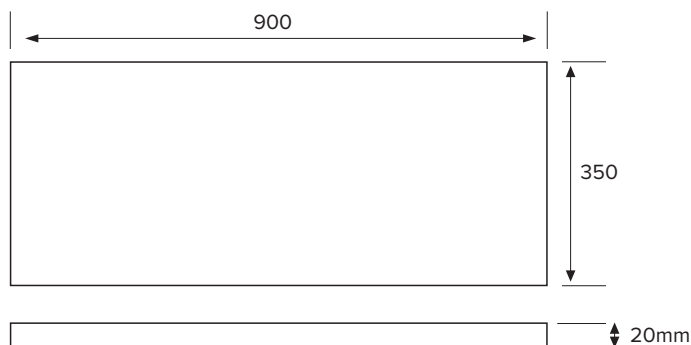

Quartz Slab Top 900

W900 x D350 x H20

Midnight Stone - Code: MS

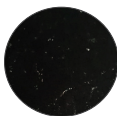

Midnight Stone

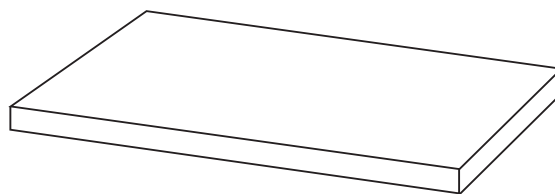

Acrylic Solid Surface Slab Top 900

W900 x D350 x H20

Sierra - Code: SIER



Sierra

Vessel Basin Options

Note: The Quarto Round 310 basins are the only compatible options available for the Slim Vanities

Quarto Round 310mm

H110 x W310

Gloss White - Code: 7331

Matte Black - Code: 7331B

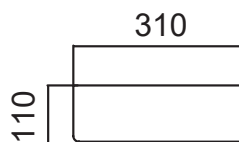
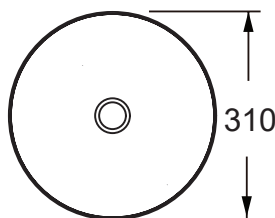

SELECT YOUR TAP HOLE POSITION (Basin Wastes pre-drilled in Quartz Options)

NTH No Tap Holes

LTH Left Tap Holes

RTH Right Tap Holes

SPECIFICATION SHEET

Designer Drawer/Door Fronts

BARNSLEY
18mm Inset Frame
Code: BL

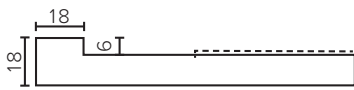

PRESTON
60mm Inset Frame
Code: PT

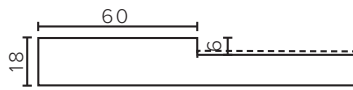
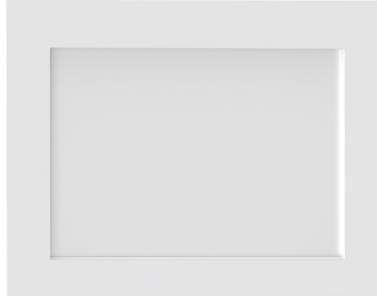

TURNBERRY
Ripple Design
Code: TB

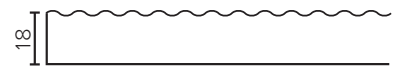

NEWPORT
V-Groove Panels
Code: NP

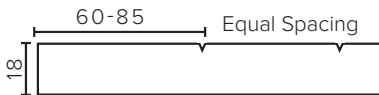

MIAMI
Little Wave
Code: MI

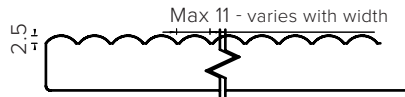
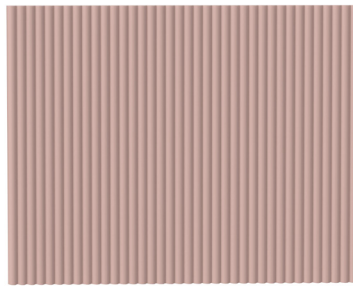

LAUREL
Fluted Lines
Code: LU

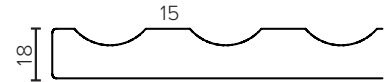
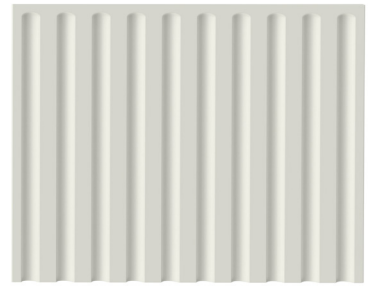

LINCOLN
Fence Style
Code: LN

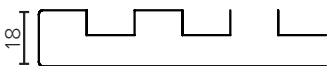
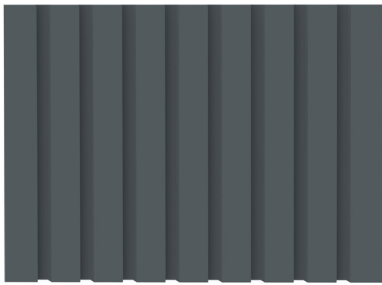

ASPEN
Scalloped Wave
Code: AP

