

SPECIFICATION SHEET

Harrow Slim 900 2-Drawer Wall Hung Vanity

Newtech Code: 5240



Features

- 2-Drawer Wall Hung Vanity with Inset Basin
- StoneCast 50mm Basin
- Full Extension Soft Close Drawers with Handle - *Handle upgrade options available*
- Dimensions: H670 x W900 x D465

See www.newtech.co.nz for the full range of basin, colour and handle options.

Technical Details

Note: All measurements shown are in millimetres. Sizes are nominal.

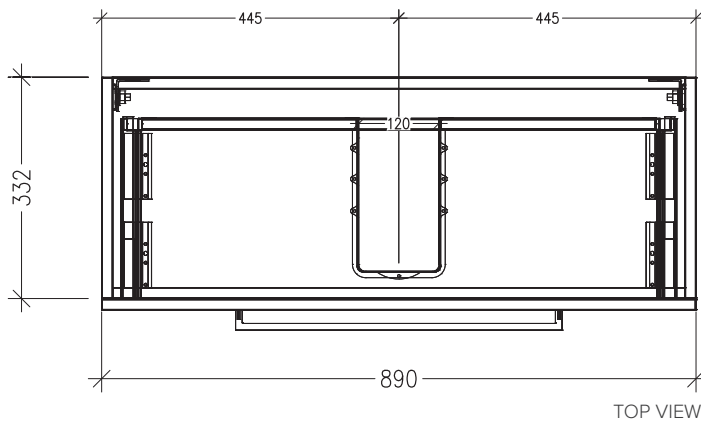

TOP VIEW

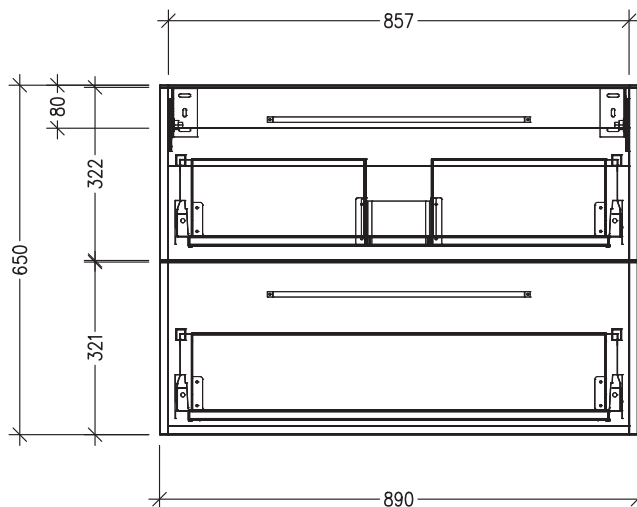

FRONT VIEW

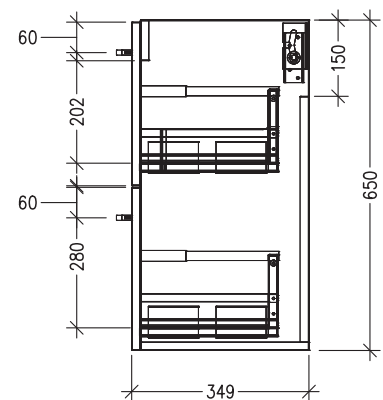

SIDE VIEW