

# SPECIFICATION SHEET

## Harrow 600mm 1-Door Mirror Cabinet

Code: 2003

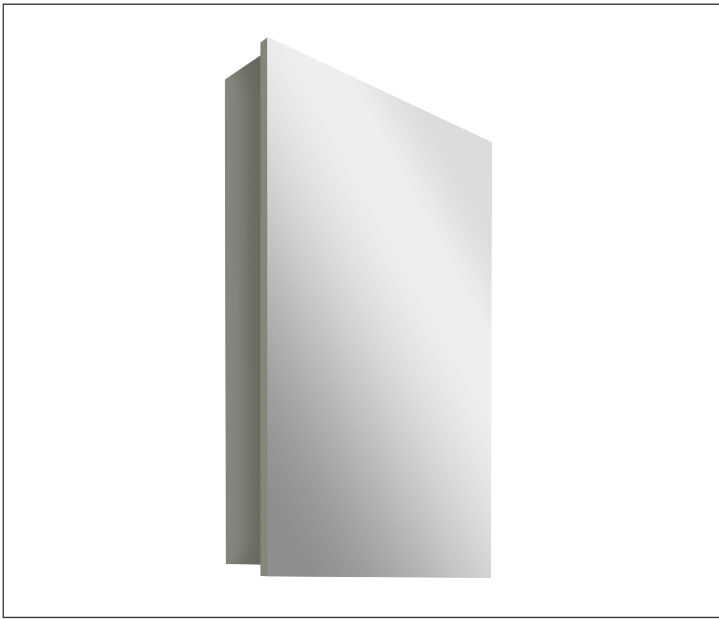

### Features

- Mirror cabinet
- 1 Door - Left or Right Hinge
- Lacquered Laminate Finish
- Dimensions: W600 x H800 X D129
- Demister available - see page 2
- Cabinet can be recessed into the wall

### Technical Details

Note: All measurements shown are in millimetres. Sizes are nominal.

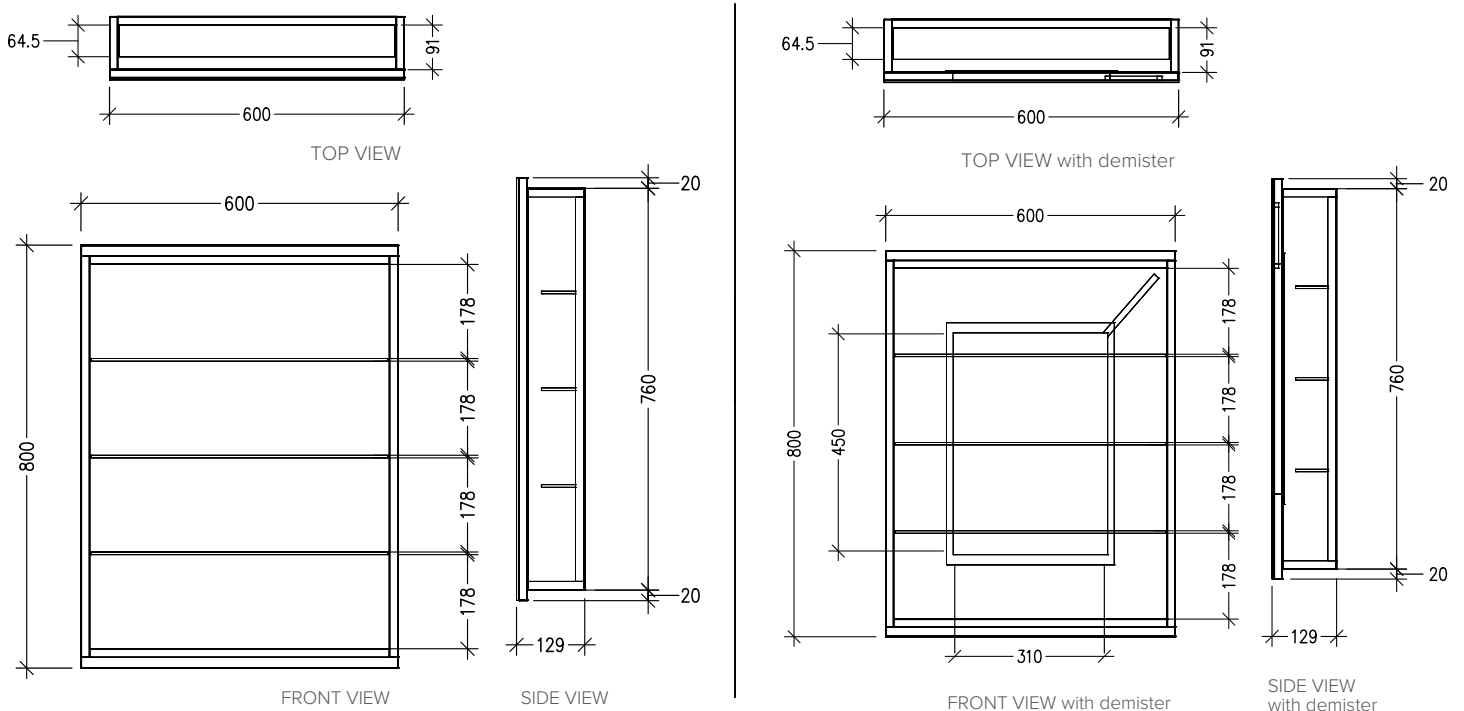

# Harrow, Avon & Kolum Mirror Cabinet Demister [88510] Specification & Installation Instructions

Newtech recommends that a registered electrician install this product and that it is installed to the current wiring regulations and in particular to those regulations that include the installation of appliances and accessories in damp environments such as bathrooms. It must be installed in accordance with relevant Australian/New Zealand Standards (AS/NZS).

The Harrow, Avon & Kolum Mirror Demister is designed to leave mirrors mist free and clear.  
The mirror demister should be operated for a few minutes before turning on the shower or running a bath.

## Sizing Guide

Mirror Size	Demister Size	Demister Required	Watts
450mm	310mm x 450mm	One	2.5W/dm <sup>2</sup>
600mm	310mm x 450mm	One	2.5W/dm <sup>2</sup>
750mm (Demister on Large Mirror Door)	310mm x 450mm	One	2.5W/dm <sup>2</sup>
900mm (Demister on Centre Mirror Door)	310mm x 450mm	One	2.5W/dm <sup>2</sup>
1200mm (Demister on Centre Mirror Door)	310mm x 450mm	One	2.5W/dm <sup>2</sup>
1500mm (Demister on Centre Mirror Door)	310mm x 450mm	One	2.5W/dm <sup>2</sup>
1800mm (Demister on Centre Mirror Door)	310mm x 450mm	One	2.5W/dm <sup>2</sup>

## INSTALLATION INSTRUCTIONS - WIRING INTO THE WALL

1. Mirror must be wired through a 230V isolation switch, either independently or combined with lighting.
2. Mirror is supplied with 600mm twin flex cable measured from outlet in mirror door.
3. Depending on mirror placement, the flex cable is located on bottom left for left hand hinged mirror doors and top right for right hand hinged mirror doors. For 450mm, 600mm and 750mm sized mirrors, the demister is located on the outside door and for the 900mm and 1200mm sized mirrors the demister is located on the middle door.

**Note: Newtech fit the mirror demister for an additional charge when purchasing an Avon or Kolum Mirror cabinet, and must be ordered at time of purchase.**

**IMPORTANT: Please note a registered electrician is required to complete all wiring installation and connections. It is recommended the mirror is wired through an RCD (Residual-current device).**