

SPECIFICATION SHEET

Frank Slim Plus 1200mm 2 Drawer Wall Vanity



Features

- Wall Hung
- 2 Drawer
- Extrusion Rail
 - Matte White Vanities = Matte White Extrusion*
 - Charred Elm Vanities = Matte Black Extrusion*
 - Planked Urban Oak Vanities = Brushed Nickel Extrusion*
- 20mm Frank Basin with Overflow
- Dimensions: H670 x W1200 x D360
- Designed & Assembled in NZ

Colour Options with Code



Matte White
2764MW



Charred Elm
2764CE



Planked Urban Oak
2764PUO



Technical Details

Note: All measurements shown are in millimetres. Sizes are nominal.

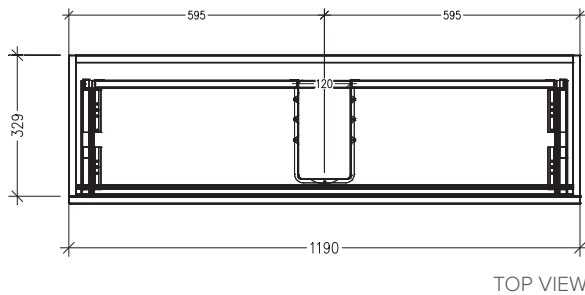

TOP VIEW

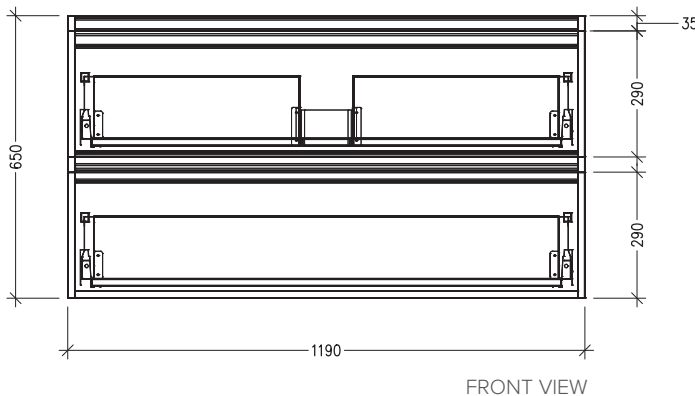
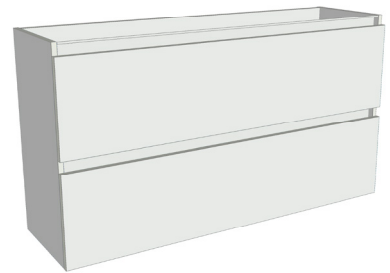

FRONT VIEW

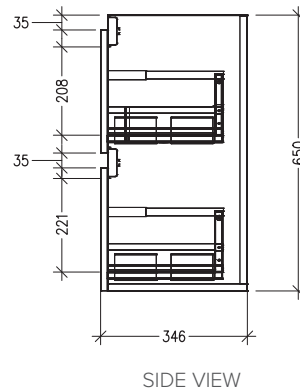

SIDE VIEW