

SPECIFICATION SHEET

Frank Plus 750mm 2 Drawer Wall Vanity



Features

- Wall Hung
- 2 Drawer
- Extrusion Rail
 - Matte White Vanities = Matte White Extrusion*
 - Charred Elm Vanities = Matte Black Extrusion Planked*
 - Urban Oak Vanities = Brushed Nickel Extrusion*
- 20mm Frank Basin with Overflow
- Dimensions: H670 x W750 x D465
- Designed & Assembled in NZ

Colour Options with Code



Matte White
9272MW



Charred Elm
9272CE



Planked Urban Oak
9272PUO



Technical Details

Note: All measurements shown are in millimetres. Sizes are nominal.

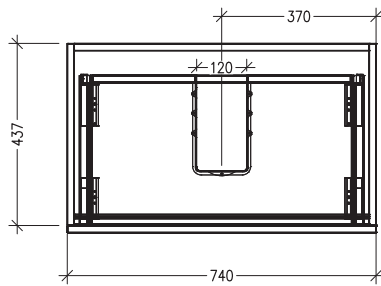

TOP VIEW

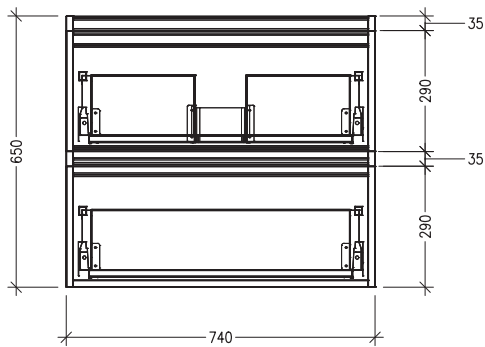

FRONT VIEW

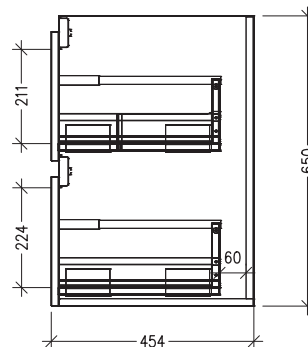

SIDE VIEW

