

# SPECIFICATION SHEET

## Frank Plus 750mm 1 Drawer Wall Vanity



### Features

- Wall Hung
- 1 Drawer
- Extrusion Rail
  - Matte White Vanities = Matte White Extrusion*
  - Charred Elm Vanities = Matte Black Extrusion Planked*
  - Urban Oak Vanities = Brushed Nickel Extrusion*
- 20mm Frank Basin with Overflow
- Dimensions: H420 x W750 x D465
- Designed & Assembled in NZ

### Colour Options with Code



Matte White  
9256MW



Charred Elm  
9256CE



Planked Urban Oak  
9256PUO



### Technical Details

Note: All measurements shown are in millimetres. Sizes are nominal.

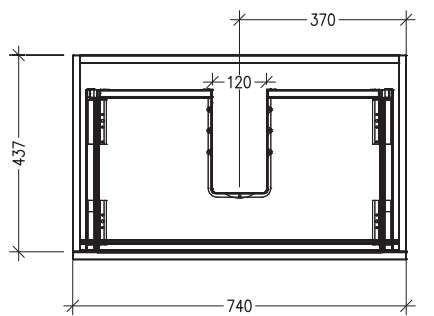

TOP VIEW

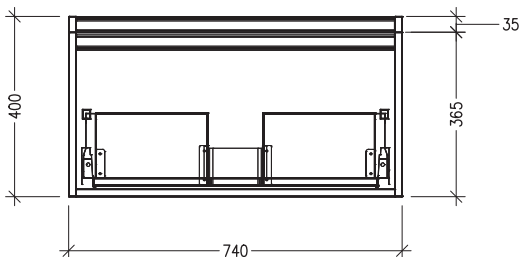
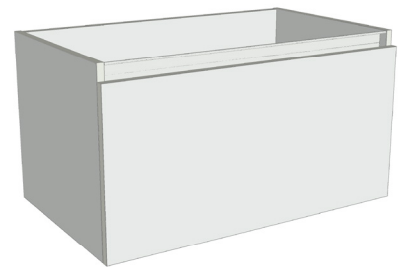

FRONT VIEW

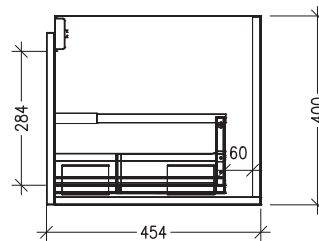

SIDE VIEW