

SPECIFICATION SHEET

Francisco Slim 900 1-Drawer Wall Hung Vanity

Newtech Code: 5426



Features

- 1-Drawer Wall Hung Vanity with Designer Drawer Front
- StoneCast 50mm Basin
- Full Extension Soft Close Drawer with Handle - *Handle upgrade options available*
- Designer Drawer Fronts are pre-installed on all vanities
- Dimensions: H420 x W900 x D350

Technical Details

Note: All measurements shown are in millimetres. Sizes are nominal.

IMPORTANT

For installation, please ensure cabinet is fixed through middle division brackets into solid fixings.

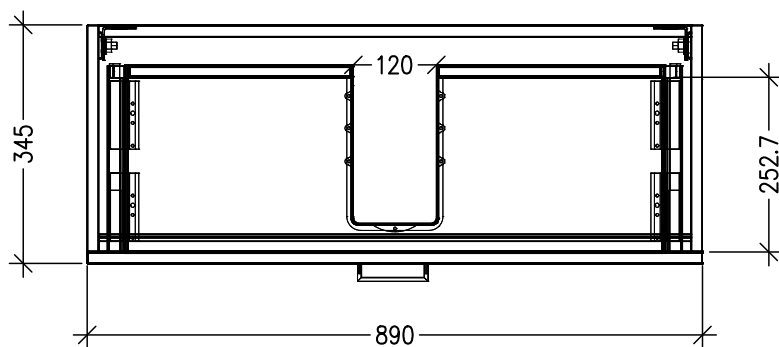

TOP VIEW



FRONT VIEW

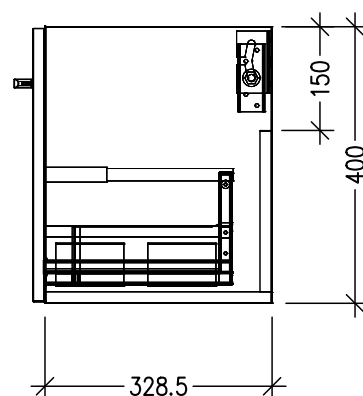

SIDE VIEW

SPECIFICATION SHEET

Designer Drawer/Door Fronts

BARNSLEY
18mm Inset Frame
Code: BL

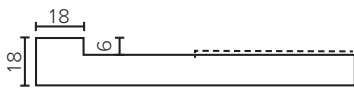
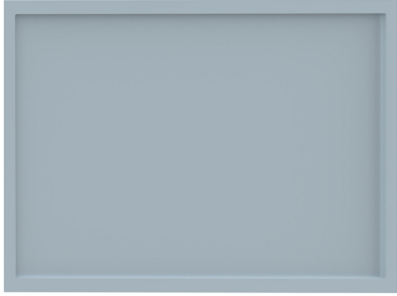

PRESTON
60mm Inset Frame
Code: PT

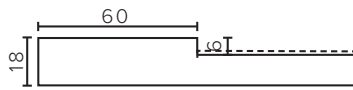
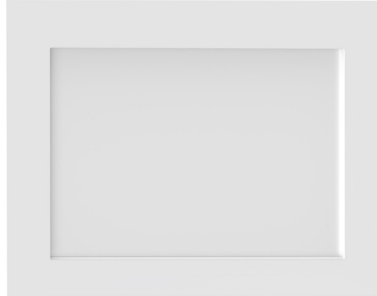

TURNBERRY
Ripple Design
Code: TB

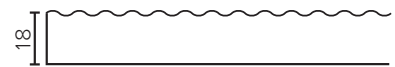

NEWPORT
V-Groove Panels
Code: NP

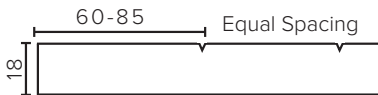

MIAMI
Little Wave
Code: MI

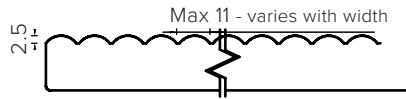
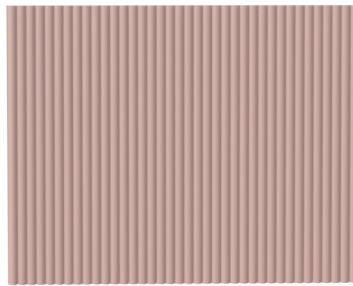

LAUREL
Fluted Lines
Code: LU

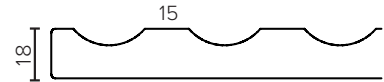
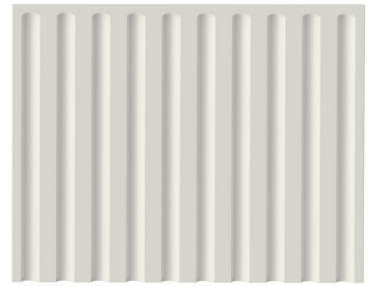

LINCOLN
Fence Style
Code: LN

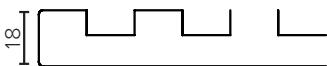

ASPEN
Scallop Wave
Code: AP

