

# SPECIFICATION SHEET

## Francisco Luxe 1500 2-Drawer Double Basin Wall Hung Vanity

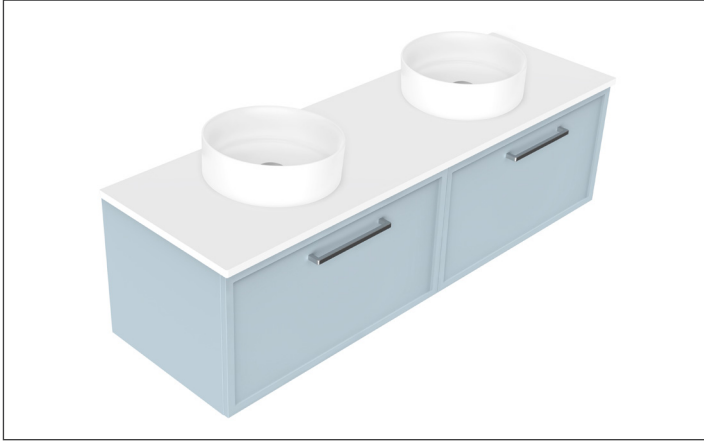

### Features

- 2-Drawer Wall Hung Vanity - Colour options below
- Full Extension Soft Close Drawers with Handles - Handle upgrade options available
- Designer Drawer Fronts - Four Drawer Front options
- Dimensions: H420 x W1500 x D465
- A variety of slab top options

*Note: Vessel basins are purchased separately.  
Visit [www.newtech.co.nz](http://www.newtech.co.nz) for the full range of vessel basin options.*

### Technical Details

Note: All measurements shown are in millimetres. Sizes are nominal.

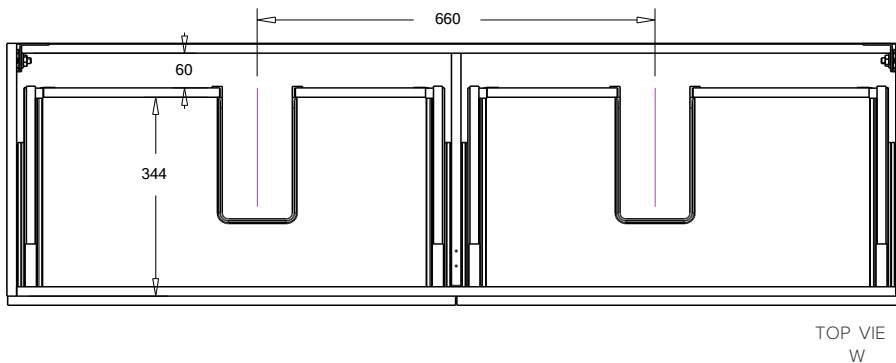

TOP VIEW  
W

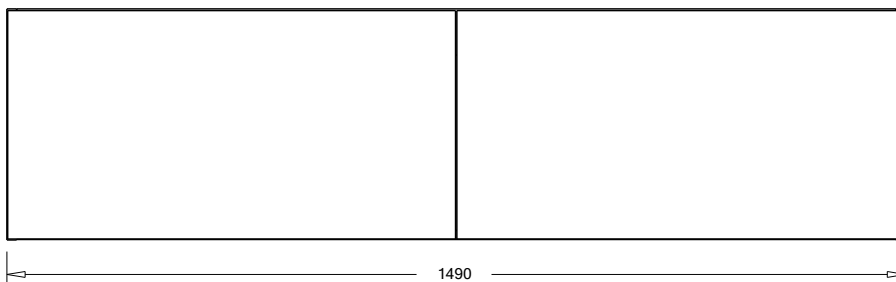
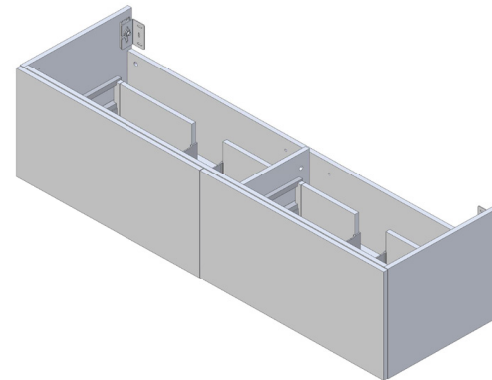

FRONT VIEW

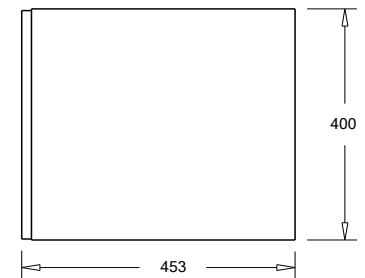

SIDE VIEW

# SPECIFICATION SHEET

## Francisco Luxe Designer Drawer Fronts

**BARNESLEY**  
18mm Inset Frame  
Code: BL

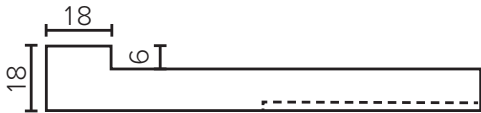
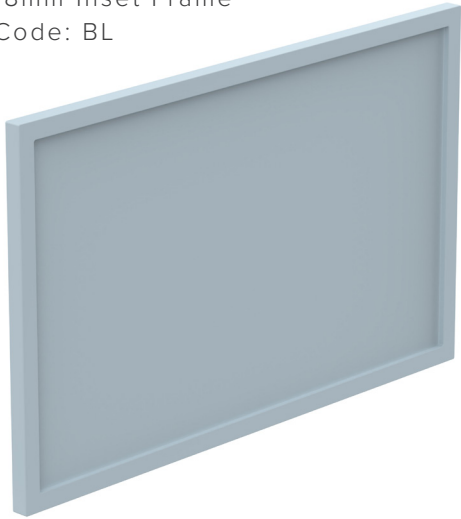

**PRESTON**  
60mm Inset Frame  
Code: PT

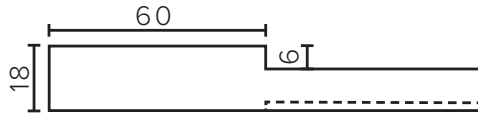
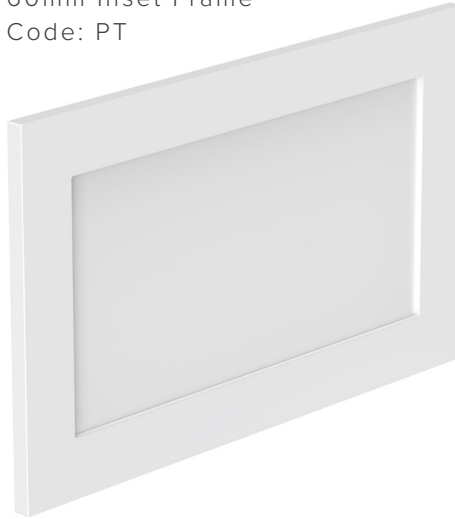

**TURNBERRY**  
Ripple Design Panel  
Code: TB

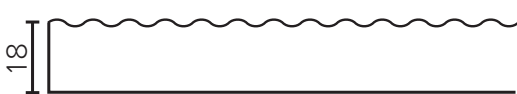
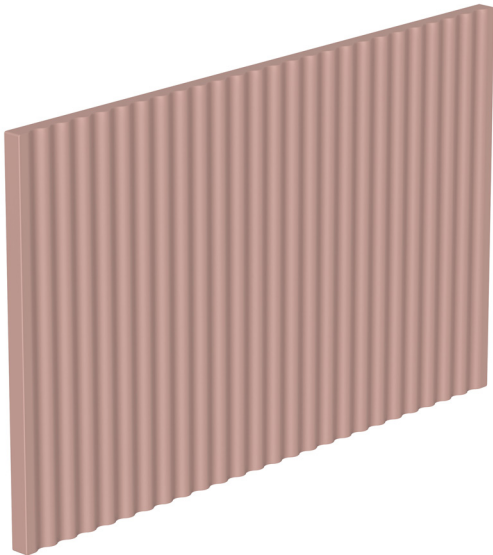

**NEWPORT**  
V-Groove Panels  
Code: NP

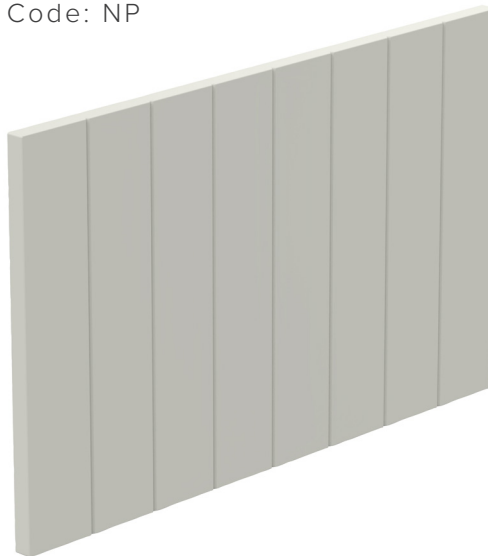

Seafoam



Iceberg

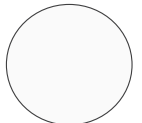

Snow White



Cherry Blossom



Slate Grey



Dusk Grey



Indigo



Matte Black