

NEWTECH ACCESSIBLE TOILET

Installation Instructions



STEP 1:

Decide if a “s” trap installation or “p” trap installation is required

“S” TRAP installation:

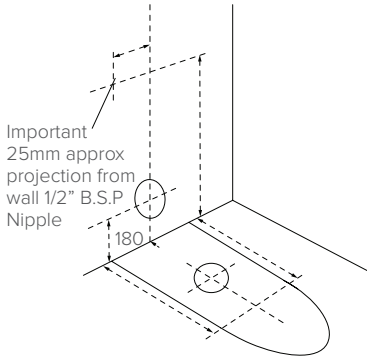

All Accessible toilet models

Newtech Accessible Toilets come with a standard S-Trap: 100-155mm.

Max setout with 100mm gooseneck pan connector 150-250mm can be purchased seperately - code 7995.

* Rough in position of water inlet, waste outlet and floor fixing bracket holes Ensure inlet connection extends 60mm from finished wall. Drill holes for floor fixing bracket then fix brackets to floor.

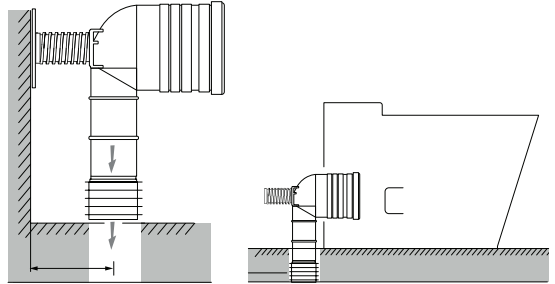

* Lubricate the fins of the pan bend and position into waste pipe.

* Lubricate rubber on the exposed connector end.

“P” TRAP installation:

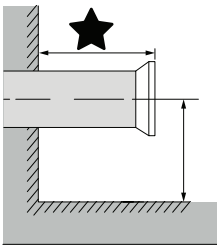

* Please measure existing toilet pan to setup p trap from wall to spigot distance. Different toilet suite may have different set out

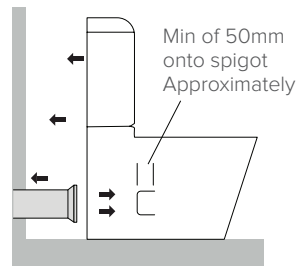

* Set up waste pipe and the end of the pan collar extends approx. Minimum of 50mm onto spigot.

STEP 2:

Do the below installation for the cistern fixing.

1. Place rubber seal into pan recess (Do not use sealant).
2. Press Pan screw A into the pan screw hole.
3. Use Nut B to tight pan screw A underneath the pan. (refer to Fig 1).
4. Place cistern screw C into holes on the inside of cistern, making sure washers are located correctly.

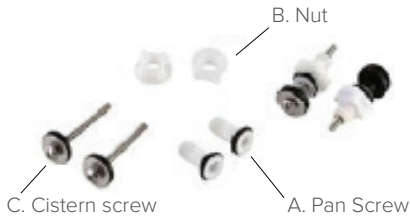

STEP 3:

Align and push fully assembled toilet back to wall, connecting pan spigot to pan collar.

Bucket flush and check for leaks. Due to the design, weight and stability of the pan and cistern, a silicon adhesive is recommended for floor based fixing.

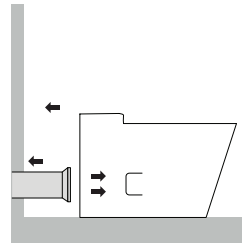

STEP 4:

Choose back inlet or bottom inlet

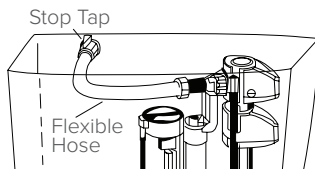

For back inlet

- * Fit off stop tap then connect rear water inlet valve to stop tap. Fill cistern and ensure correct water level

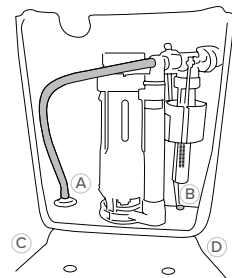

For bottom inlet

- * Remove cap from cistern plug A or B at base cistern. Connect flexible hose to cistern plug A or B depending on location of stop tap. Complete stop tap connection to underside of cistern plug A or B. Fill cistern and ensure correct water level.

Note: Inlet valve can be adjusted if required.

STEP 5:

Gently lower the cistern onto the pan, locating the fixing screws into the pan screw holes ensuring the cistern is placed evenly over the cistern area of the pan. Do not tighten the cistern to the pan initially until the Cistern is centred over the pan. Note: there should be a slight overhang of the cistern on the pan. The Cistern holes allow for a little left and right adjustment and front to back adjustment. Once the cistern is aligned well then tighten the fixing screws.

NOTE: Before tightening the cistern to the pan, ensure they are sitting flush against the wall.

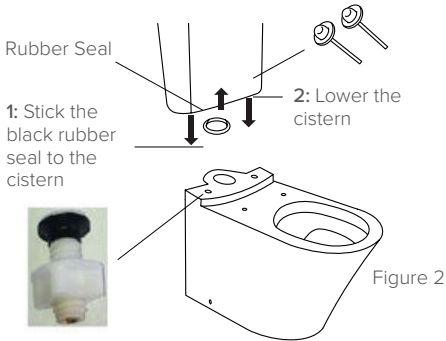

Figure 3

SPECIFICATIONS

Accessible Toilet Suite - **8003, 8005, 8007, 8009**

